

# A Single-Phase Low-frequency Commutation Inverter for Renewables

Geomar Machado Martins\*, José Antenor Pomilio

School of Electrical and Computer Engineering  
University of Campinas

C. P. 6101 13081-970 Campinas – Brazil  
e-mail: {geomar} {antenor}@dsce.fee.unicamp.br

\* Federal University of Santa Maria

Simone Buso

Department of Electronics and Informatics  
University of Padova

Via Gradenigo 6/a 35131 Padova – Italy

e-mail: simone.buso@dei.unipd.it

**Abstract** - Co-generation systems integrating distributed low-power sources with the utility generally ask for an electronic power converter for conditioning the locally generated power and inject current into the grid. If the source provides a DC voltage, the converter should be able to produce a low-distortion, high-power factor AC current. For low-power applications, like photovoltaic panels and fuel cells, a single-phase inverter (DC-AC converter) can be used for connecting the source with the grid. The paper describes a single-phase DC-AC topology for interfacing DC sources with the utility. The commutation of the power switches is at the line frequency. The main advantages of the proposed converter are: (1) negligible switching losses – high efficiency; (2) negligible EMI; (3) the current injected into the grid presents low harmonic distortion and high power factor; (4) higher reliability compared to PWM inverters (due to the simpler control circuitry). The power flux can be controlled either by varying the DC voltage or controlling the switches command.

## I. INTRODUCTION

The connection of distributed low-power sources with the utility generally asks for an electronic power converter for conditioning the locally generated power and injecting current into the system. If the source provides a DC voltage, the converter must be able to produce a low-distortion, high power factor AC current. The same aspects related with the voltage and current distortion produced by the loads can be considered for the injection of power into the grid, as in distributed generation systems, especially if switched-mode power electronics converters process the power.

In the absence of specific standards, this paper takes as into account the limits for current distortion given by the standard EN61000-3-2 [1] to verify the quality of the current injected into the line. The justification for this approach is that, from the resulting line voltage degradation, there is no difference between injected and absorbed current. In fact, the standard uses the word “emissions” to characterize the current harmonics.

This standard is valid for single and three-phase loads up to 16 A per phase (230 V).

For low-power applications, like photovoltaic panels and fuel cells, a single-phase inverter (DC-AC converter) can be used for connecting the alternative source with the grid.

It is well known that PWM controlled power converters can be used to produce any voltage or current waveforms. This modulation technique has been used for many applications, including the connection of DC sources to the grid [2]. Typical PWM waveforms for a three-level inverter

are shown in Fig. 1. A suitable low-pass filter is necessary to attenuate the high-frequency components due to the switching. In this example the output is a voltage, but the converter can be controlled in order to synthesize a current.

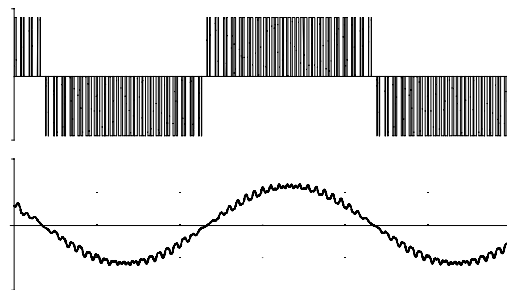

Fig. 1 – Three-level PWM waveform and filtered resulting voltage.

The main advantage of the use of PWM inverters for renewables sources interface is the excellent current waveform. Nevertheless these converters present some drawbacks especially related with the EMI generation, due to the high-frequency commutation, and a relatively low efficiency, due to the power switches losses.

These converters are considered a standard for industrial and UPS applications, but they do not satisfy the cost requirement for low power co-generation applications [3]. There are other converter topologies suitable for grid interfaces applications [4], but they also use high-frequency commutation, thus EMI filter are still necessary if one is interested in injecting a low-distortion current into the line.

## II. THE PROPOSED TOPOLOGY

Seeking for low-cost, high-reliability, low-distortion DC-AC converters, the operation principles of the line-frequency commutated rectifiers [5-7] were considered for the inverse conversion. In these topologies an auxiliary circuit is added to the conventional diode bridge rectifier, improving the line current waveform in order to comply with the standard EN 61000-3-2. The auxiliary circuit can present different topologies and behaviors but all of them use a controlled switch (generally an IGBT) plus passive filtering components (inductors and capacitors).

The main advantages of this approach are: (1) negligible switching losses → high efficiency; (2) negligible EMI; (3) the current injected into the grid presents low harmonic distortion and high power factor; (4) higher reliability compared to PWM inverters (due to the simpler control

circuitry). The proposed single-phase inverter is shown in Fig. 2. The source can be any kind of DC supply, as fuel cell, solar panel, batteries, etc., even if connected to the inverter DC side through a DC-DC converter.

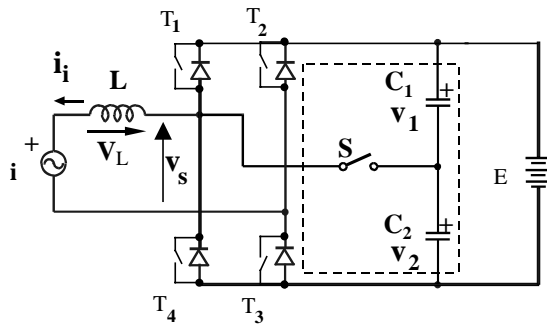

Fig. 2 – Single-phase low-frequency commutation DC-AC converter

#### A. Design Procedure – without the auxiliary circuit

There are different strategies to control the switches. The simplest one does not use the auxiliary circuit. In this case, the current injected into the grid is controlled only by the bridge' switches.

Some design guidelines must be initially established:

- At rated power, the generated current must present low total harmonic distortion (THD) and high displacement factor, resulting in a very high power factor. The fundamental component must be in phase with the line voltage.
- $T_3$  conducts during the whole positive half-cycle of the line voltage.  $T_2$  does the same during the negative half-cycle.
- $T_1$  conducts during an adjustable interval  $\theta_1$  (between 0 and  $\pi$ ) during the positive half-cycle of the line voltage.  $T_4$  does the same during the negative half-cycle. During the positive half-cycle, when  $T_1$  turns-off there is a free-wheeling interval. The same occurs at the negative interval.
- The power flow from the source to the line can be controlled: (1) by varying the DC voltage, or (2) by adjusting the phase angle between the first harmonic of the inverter voltage ( $v_{s1}$ ) and the line voltage, or (3) by combining both methods.
- The resulting current distortion must comply with [1].

The fundamental component of the line current must be in phase with the line voltage in order to minimize its RMS value for a given power level (unity Power Factor). This means that the voltage across the inductance,  $v_L$ , must lead  $90^\circ$  the line voltage, as shown in Fig. 3. The fundamental component of the voltage produced by the inverter,  $v_{s1}$ , is than geometrically determined.

The first harmonic of the line current determines the generated power, considering  $v_i$  is constant. The relationship between  $v_L$  and  $i_i$ , for each harmonic, is the respective reactance. If one consider only the fundamental frequency, at the limit,  $v_{s1}$  tends to  $v_i$ ,  $\alpha$ ,  $v_L$  and  $L$  tend to zero.

Obviously this solution cannot be adopted because, for the harmonics, the current would be very high. So the selection of the inductance value also depends on the harmonic current limits [1] and not only on the fundamental.

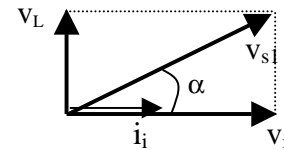

Fig. 3 - Phasorial representation of the AC voltages.

A general waveform produced by the inverter is shown in Fig. 4. The angle  $\gamma$  can vary in order to produce the necessary phase angle shift with the line voltage (for  $v_{s1}$ ). This variation also alters the first harmonic RMS value and the harmonic content.

The maximum DC voltage can be choose considering the maximum power, the inverter power switches and capacitors.

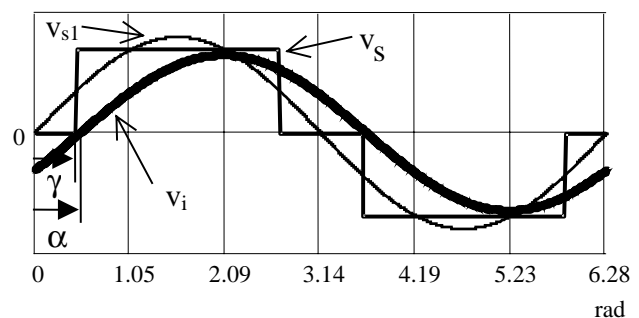

Fig. 4 - Inverter output voltage,  $v_s$ ; its first harmonic,  $v_{s1}$ ; line voltage,  $v_i$ .

The RMS value of the odd harmonics is given by:

$$a_h = \frac{2\sqrt{2} \cdot \cos(h \cdot \gamma) \cdot E}{h \cdot \pi} \quad h=1,3,\dots \quad (1)$$

The maximum DC voltage establishes a range for the angle  $\gamma$ . The minimum value is zero (square wave) and the maximum is:

$$\gamma_{\max} = \cos^{-1} \left( \frac{V_i \cdot \pi \cdot \sqrt{2}}{4 \cdot E} \right) \quad (2)$$

A narrow pulse ( $\gamma > \gamma_{\max}$ ) would not produce the current fundamental component necessary to inject the rated power into the grid.

For a specific DC voltage and for each possible  $\gamma$  value, it is possible to determine the minimum inductance that, for each harmonic, guarantees that the respective current is at the limit value. For the fundamental component the limit is the current associated with the maximum power.

The feasible region is the one delimited by the first harmonic component in which the respective inductance is the maximum one. The selected inductance is the minimum one belonging to this set. Outside of this range the harmonics would exceed the limits.

The results shown in Fig. 5 were obtained for:  $E=325\text{V}$ ,  $V_i=230\text{ V}_{\text{RMS}}$ ,  $P=3.68\text{ kW}$  ( $I_i=16\text{ A}_{\text{RMS}}$ ),  $\omega_i=2\pi \cdot 50\text{ rd/s}$ . The figure shows a front view of the resulting surface plot. The best choice is for  $\gamma=26^\circ$ , given  $L=25.7\text{ mH}$  (limit for 1<sup>st</sup> harmonic),  $\gamma_{\max}=43^\circ$ .

The last procedure is to determine the angle  $\alpha$  between  $v_{s1}$  and  $v_i$  that ensures  $PF=1$ . In this case  $\alpha=29^\circ$ .

$$\alpha = \sin^{-1} \left( \frac{\sqrt{2} \cdot \pi \cdot P \cdot \omega_i \cdot L}{4 \cdot \cos(\gamma) \cdot V_i \cdot E} \right) \quad (3)$$

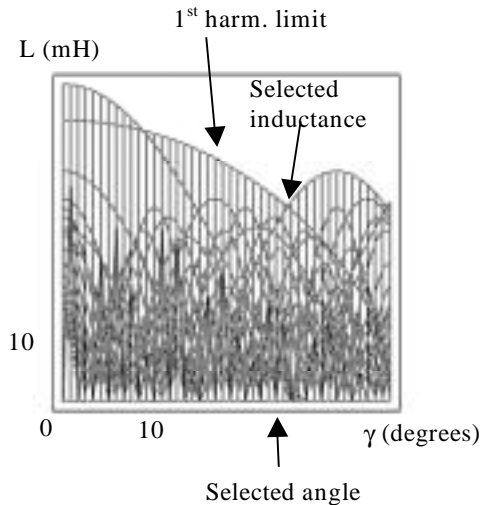

Fig. 5 - Inductances necessary to inject the generated power and to comply with the harmonic limits.

For the positive half-cycle, the equivalent topologies are shown in Fig. 6. In these intervals the line current is given by:

For  $0 < \theta < \theta_1$

$$i_i(\theta) = \frac{E \cdot \theta + V_p \cdot (\cos \theta - 1)}{X_L} + i_i(0) \quad (4)$$

For  $\theta_1 < \theta \leq \pi$

$$i_i(\theta) = \frac{V_p \cdot (\cos \theta - \cos \theta_1)}{X_L} + i_i(\theta_1) \quad (5)$$

Where:

$$X_L = \omega_i \cdot L$$

$$v_i(t) = V_p \cdot \sin(\omega_i \cdot t)$$

$$\theta = \omega_i \cdot t$$

Fig. 7 shows the waveforms for the maximum current level established in [1], 16 A. The power factor is 0.99 and the current THD is 9,5%. Fig. 8 shows the current spectrum, indicating that the current comply with [1].

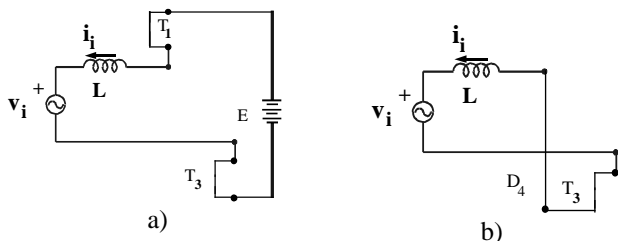

Fig. 6 - a)  $0 < \theta < \theta_1$  ( $T_1$  and  $T_3$  conducting); b)  $\theta_1 < \theta < \theta_2 \leq \pi$  ( $T_3$  and  $D_4$  conducting).

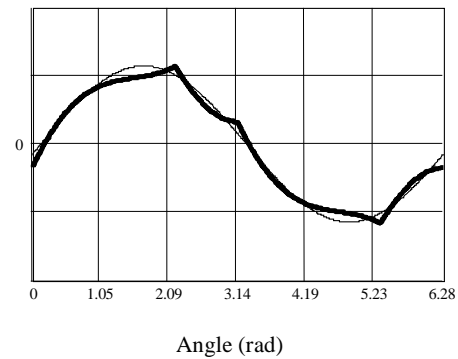

Fig. 7 - Line current its first harmonic.

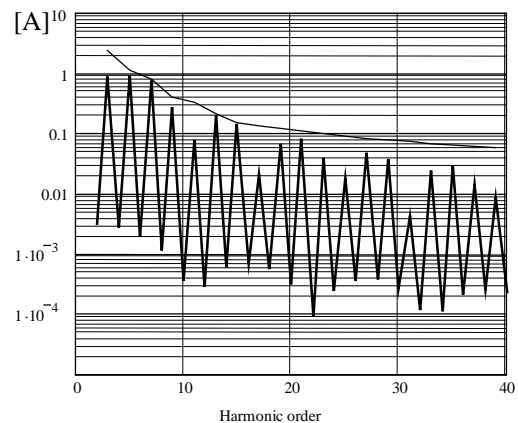

Fig. 8 - Current spectrum and standard limits (upper trace).

### B. Command strategy - with the auxiliary circuit

In this case, the current injected into the grid is mainly controlled by the bridge' switches but its waveform depends on the auxiliary circuit behavior. During the resonant interval the inverter output voltage varies softly, reducing the voltage THD and consequently the current distortion. In order to comply with [1] it is possible to use an inductance lower than the one calculated in the previous section. The equivalent circuits are shown in Fig. 9.

Some design guidelines must be initially established:

- $T_3$  conducts during the whole positive half-cycle of the line voltage.  $T_2$  does the same during the negative half-cycle.
- $T_1$  conducts during an adjustable interval  $\theta_1$  (between 0 and  $\pi$ ) during the positive half-cycle of the line voltage.  $T_4$  does the same during the negative half-cycle.
- Auxiliary switch, S, turns-on when  $T_1$  or  $T_4$  turn-off. During its conduction there is a resonance between L and  $2C$  ( $C=C_1=C_2$ ). The conduction angle ( $\theta_s$ ) can be adjusted to minimize the inductance value.
- The on-time of  $T_1$  and S must be adjusted in order to avoid negative current into the DC side.
- The resulting current distortion must comply with [1].

In these intervals the line current is given by:

For  $0 < \theta < \theta_1$

$$i_i(\theta) = \frac{E \cdot \theta + V_p \cdot (\cos \theta - 1)}{X_L} + i_i(0) \quad (6)$$

For  $\theta_1 < \theta < \theta_2$  resonance

$$i_i(\theta) = \frac{V_p \cdot \cos(\theta)}{X_L \cdot (\alpha^2 - 1)} + \frac{1}{X_L} \left[ V_p \left( \frac{\alpha}{\alpha^2 - 1} \right) \cdot \sin(\theta_1) - \frac{v_2(\theta_1)}{\alpha} \right] \cdot \sin(\alpha \cdot (\theta - \theta_1)) - \frac{1}{X_L} \left[ E \cdot \theta_1 - V_p \cdot \left( \frac{\alpha^2 \cdot \cos(\theta_1)}{\alpha^2 - 1} \right) \right] \cdot \cos(\alpha \cdot (\theta - \theta_1)) \quad (7)$$

$$v_2(\theta) = \frac{V_p \cdot \alpha^2 \cdot \sin(\theta)}{\alpha^2 - 1} + \left\{ V_p \cdot \alpha \cdot \left[ 1 - \frac{\alpha^2 \cdot \cos(\theta_1)}{\alpha^2 - 1} \right] - E \cdot \alpha \cdot \theta_1 \right\} \cdot \sin[\alpha \cdot (\theta - \theta_1)] + \left[ v_2(\theta_1) - \frac{V_p \cdot \alpha^2 \cdot \sin(\theta_1)}{\alpha^2 - 1} \right] \cdot \cos[\alpha \cdot (\theta - \theta_1)] \quad (8)$$

For  $\theta_2 < \theta < \theta_3 \leq \pi$

$$i_i(\theta) = \frac{V_p \cdot (\cos \theta - \cos \theta_2)}{X_L} + i_i(\theta_2) \quad (9)$$

Where:

$$\omega_o = \frac{1}{\sqrt{2LC}}$$

$$\alpha = \frac{\omega_o}{\omega_i}$$

$v_2(\theta_1)$ :  $C_2$  initial voltage at  $\theta = \theta_1$

$$v_1(\theta) + v_2(\theta) = E$$

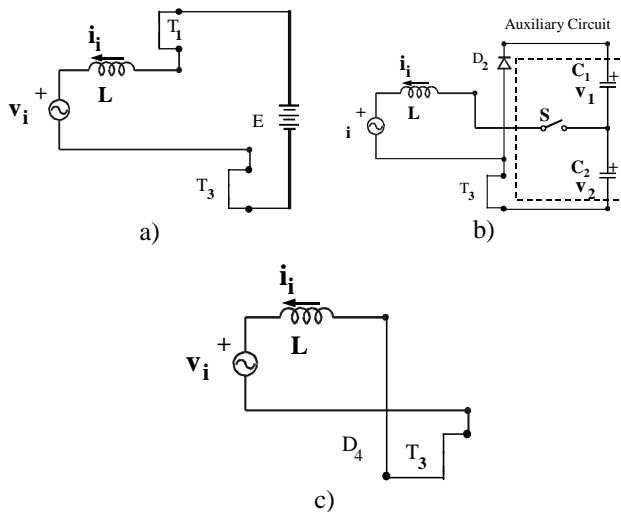

Fig. 9 - a)  $0 < \theta < \theta_1$  ( $T_1$  and  $T_3$  conducting); b)  $\theta_1 < \theta < \theta_2$  (resonance); c)  $\theta_2 < \theta < \theta_3 \leq \pi$  ( $T_3$  and  $D_4$  conducting).

Fig. 10 shows the waveforms for the maximum current level established in [1], 16 A, @ 230V. It was used a lower inductance value ( $L=19$  mH), the same inverter commands as used in the previous result, and  $C=100\mu\text{F}$ . The DC voltage was reduced to 290V in order to obtain the rated power. Note that with these inductance and DC voltage reduced values would not be possible get the desired performance with the previous circuit (without the auxiliary circuit).

The auxiliary switch turns-on when the bridge switch turns-off ( $T_1$  or  $T_4$ ) and conducts until to complete the half-cycle. The resulting power factor is 0.986 and the THD is 14.1%.

Fig. 11 shows the current spectrum, indicating that the current comply with [1]. In this case the limit was determined by the 3<sup>rd</sup> harmonic. The 15<sup>th</sup> and 17<sup>th</sup> also are close to the limit.

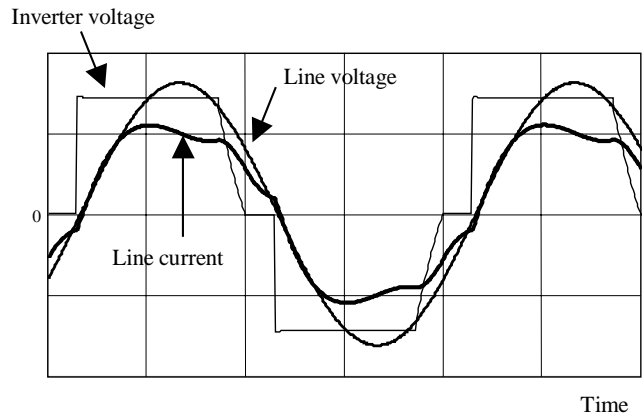

Fig. 10 – Inverter voltage, line voltage and injected current for the topology with auxiliary circuit.

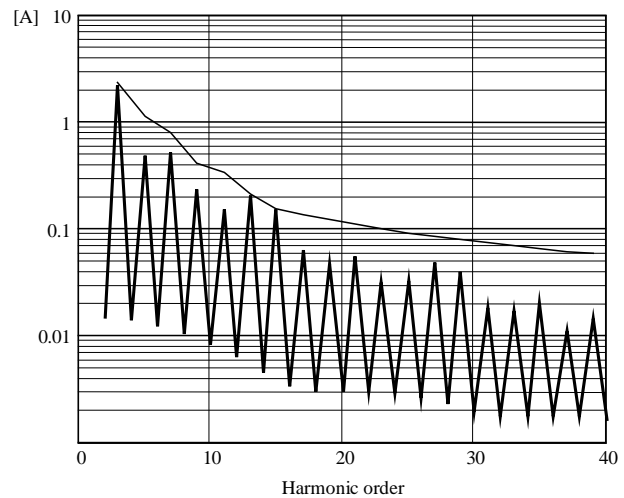

Fig. 11 – Line current spectrum for the topology with auxiliary circuit and standard limit (upper trace).

### C. Reduced power operation

In order to maintain low current distortion, the best procedure to reduce the co-generated power is to decrease the DC voltage, extending the duty-cycles of  $T_1$  (or  $T_4$ , during the negative half-cycle). There is a minimum DC value for which the input current does not become negative. To avoid this undesirable circuit behavior it is necessary that, when the line current goes to zero, the diodes' bridge be reverse polarized (i.e.  $E > v_i(\theta)$ ). Below this level it is necessary to reduce the duty-cycle of  $T_1$  (or  $T_4$ ). Fig. 12 shows the waveforms for reduced power, with the auxiliary circuit operation.

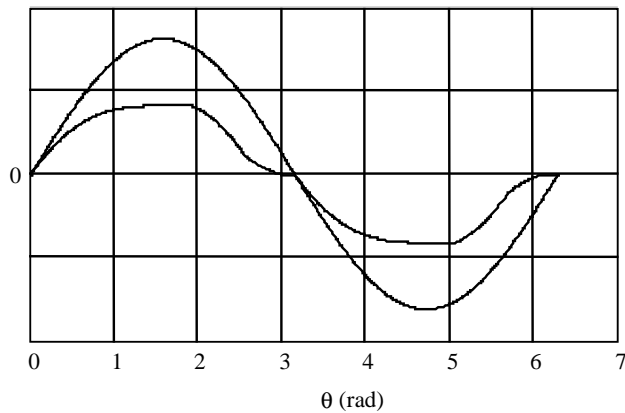

Fig. 12 –Line voltage and current @  $E=V_p$ ,  $\theta_i=1.9$  rad,  $\theta_s=0.65$ ,  $P=2.7$  kW,  $PF=0.98$

#### D. Command strategy – without the line

This system has been conceived to operate delivering the generated power to the line. The local load is connected at the point of common coupling, thus the grid naturally regulates the voltage. The DC source can continuously produce the nominal power and it does not need a control scheme because all the generated power is locally consumed or delivered to the grid. Additionally, if the local generated power is not sufficient to supply the load, the additional power automatically comes from the utility.

A problem arises in the absence of the grid connection. In this case it is necessary to energize the local load with a suitable voltage and consume all the generated power. Note that, in the presence of the line, the converter works as a current source. But without this connection the main objective is to produce an acceptable voltage waveform. This can be obtained adding a suitable capacitor in parallel with the grid. This component could be used for power factor compensation during normal operation but, if the line is not present, it will determine the voltage.

The DC source must be adjusted in order to produce an adequate voltage. To minimize the voltage THD, the output filter should have a resonance close to the line frequency, but this produces a high circulating current through the switches. If a voltage THD about 20% is acceptable, even feeding non-linear loads (single-phase rectifier with capacitive filter), a small capacitor can be used.

One possible approach is to regulate the output voltage in order to have a peak voltage equal to the sinusoidal one. This would produce the same voltage on rectifier-based loads (computers, TV sets, ballasts, etc.), which are the most usual non-linear loads. If resistive loads are connected, they would increase the power consumption.

Another possibility is to regulate the RMS voltage. In such situation resistive loads would not be affected, but electronic loads probably would received a lower voltage due to the peak value reduction.

Figure 13 shows the output voltage in this situation (for non-linear load). At  $t=100$ ms the grid is disconnected and the load voltage is determined by the inverter. The peak voltage

is maintained approximately constant. The resulting THD is 22%. The output capacitor is  $C=30$   $\mu$ F.

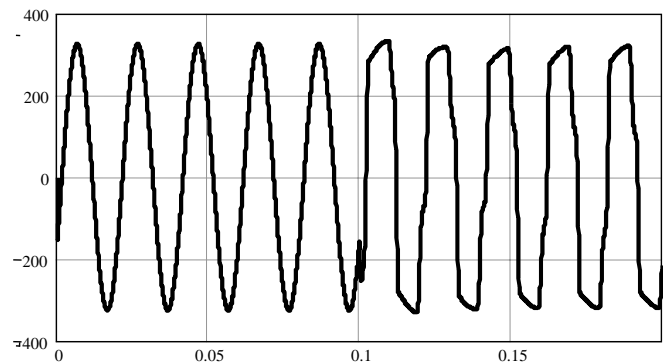

Fig. 13. Load voltage with and without the grid connection.

### III. EXPERIMENTAL RESULTS

Results from a prototype are shown in Figs. 14, 15 and 16. The inductance is 36 mH and the auxiliary capacitors are 22  $\mu$ F.

Without the auxiliary circuit (Fig. 14) for a line voltage of 220V, the circuit injects 740W into the grid. The power factor is 0.985 and the current harmonics comply with the limits.

Fig. 15 shows the converter connected to a 127 V grid. The current distortion is reduced due to the action of the auxiliary circuit. The DC voltage is 180 V and the inverter switching pattern is the same of the previous test. The auxiliary switch conducts for  $34^\circ$ , after the inverter switches turn-off. The resulting power factor is 0.99.

Fig. 16 shows the load voltage without the grid connection. The output capacitance is 30  $\mu$ F. The output voltage peak value is maintained the same of the grid voltage.

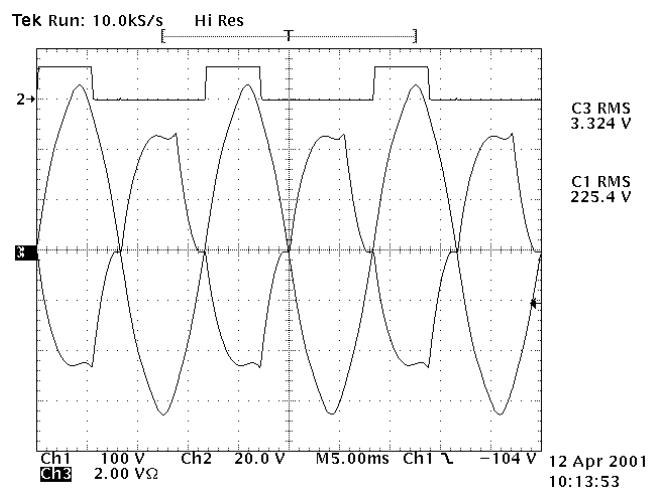

Fig. 14 – Experimental results, without the auxiliary circuit. From top to bottom:  $T_1$  command; Line voltage; line current.

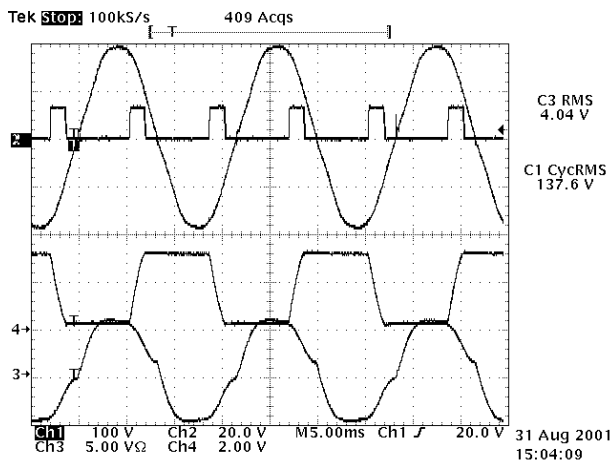

Fig. 15 – Experimental results, with the auxiliary circuit.

From top to bottom: Line voltage (100 V/div.), auxiliary switch command; auxiliary capacitor  $C_2$  voltage (100 V/div.), line current (2A/div.)

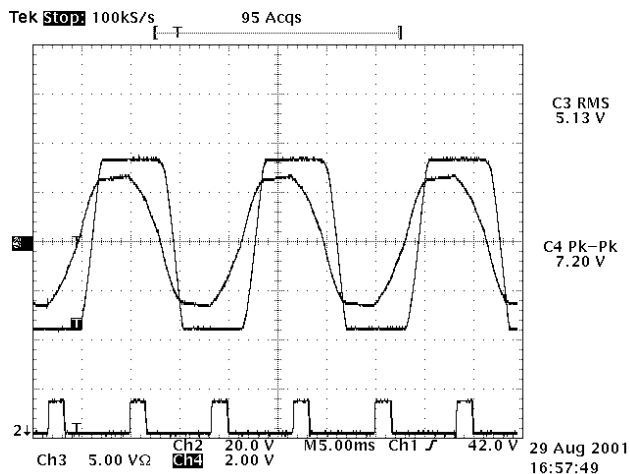

Fig. 16 – Load voltage (50 V/div.), auxiliary switch command and inductor current (5 A/div.) for operation without the grid.

#### IV. CONCLUSIONS

The proposed single-phase, low-frequency commutation inverter presents some interesting characteristics if one is looking for low-cost, good-quality inverters suitable for distributed generation systems, based on DC primary sources, connected with the utility grid. Taking as quality parameter the current distortion limits established in international standards, the current injected into the grid by the topology presents low distortion and high-power factor. As the circuit operates at the line frequency, EMI filters are not necessary, and the switching losses can be neglected,

thus reducing the heatsink area. The inductor is designed for the line frequency, thus using Fe-Si or equivalent core, and typically has a relatively high inductance value. Nevertheless, considering the overall volume, for the high power level (above 2 kW) it can be expected a volume smaller than in PWM inverters.

#### V. ACKNOWLEDGEMENT

Authors would like to acknowledge the Fundação de Amparo à Pesquisa do Estado de São Paulo – FAPESP and Fundação CAPES by the support of this project.

#### VI. REFERENCES

- [1]. EN61000-3-2, Limits for harmonic current emissions (equipment input current up to and including 16A per phase) First Edition 1995, European Committee for Electrotechnical Standardization, Brussels, Belgique.
- [2]. G. A. O'Sullivan, "Fuel Cell Inverter for Utility Applications", CD-ROM of the IEEE Power Electronics Specialists Conference, Galway, Ireland, June 2000.
- [3]. U.S. Department of Energy et al., "2001 Future Energy Challenge", Homepage URL: [HYPERLINK](http://energy.uiuc.edu/energychallenge/main.html/FutureEnergyChallenge) <http://energy.uiuc.edu/energychallenge/main.html/FutureEnergyChallenge>
- [4]. G. Ledwich and P. Wang, "Simple Grid Interfaces for Renewables", International Journal of Renewable Energy Engineering, vol. 1, No. 2, August 1999, pp. 50-55.
- [5]. I. Suga, M. Kimata, Y. Ohnishi, R. Uchida, "New Switching Method for Single-Phase AC to DC Converter", PCC Conf. Proc., Yokohama, 1993, pp. 93-98
- [6]. L. Rossetto, G. Spiazzi, P. Tenti, "Boost PFC with 100Hz Switching Frequency providing Output Voltage Stabilization and Compliance with EMC Standards," IEEE Transaction on Industry Applications, vol.36, n.1, January/February, 2000, pp.188-193.
- [7]. J. A. Pomilio, G. Spiazzi, "A Double-Line-Frequency Commutated Rectifier Complying with IEC 1000-3-2 Standards", IEEE Applied Power Electronics Conf. Proc. (APEC), March, 1999, pp. 349-355.
- [8]. J. A. Pomilio, G. Spiazzi, S. Buso, "Comparison among High-Frequency and Line-Frequency Commutated rectifiers Complying with IEC 61000-3-2 Standards", CD-ROM of the IEEE IAS Conference, Rome, Italy, Oct. 2000.
- [9]. J. A. Pomilio: "Disposição construtiva introduzida em conversor CC-CA monofásico com comutação em baixa frequência e baixa distorção harmônica". INPI, Patent pending MU 8.100.701-9, Brazil.